



Main

Range of product	Altivar Process ATV600
Product or component type	Variable speed drive
Product specific application	Process and utilities
Device short name	ATV630
Variant	Standard version
Product destination	Asynchronous motors Synchronous motors
Mounting mode	Floor-standing
EMC filter	Integrated EN/IEC 61800-3 category C3
IP degree of protection	IP21 IEC 61800-5-1 IP21 IEC 60529
Type of cooling	Forced convection
Supply frequency	50...60 Hz - 5...5 %
Network number of phases	3 phases
[Us] rated supply voltage	380...440 V - 15...10 %
Motor power kW	315 kW normal duty 250 kW heavy duty
Line current	538 A 400 V normal duty 432 A 400 V heavy duty 566 A 380 V normal duty 453 A 380 V heavy duty
Prospective line I _{sc}	50 kA
Apparent power	373 kVA 440 V normal duty 299 kVA 440 V heavy duty
Continuous output current	590 A 2.5 kHz normal duty 477 A 2.5 kHz heavy duty
Maximum transient current	649 A 60 s normal duty 715.5 A 60 s heavy duty
Async motor control profile	Variable torque standard Constant torque standard Optimized torque mode

Disclaimer: This documentation is not intended as a substitute for and is not to be used for determining suitability or reliability of these products for specific user applications

Synchronous motor control profile	Permanent magnet motor
Speed drive output frequency	0.1...599 Hz
Output frequency	0.0001...0.5 kHz
Nominal switching frequency	2.5 kHz
Switching frequency	2...8 kHz adjustable 2.5...8 kHz with derating factor
Safety function	STO (safe torque off) SIL 3
Discrete input logic	16 preset speeds
Communication port protocol	Ethernet Modbus TCP Modbus serial
Option card	Communication module Profibus DP V1 slot A Communication module Profinet slot A Communication module DeviceNet slot A Communication module Modbus TCP/EtherNet/IP slot A Communication module CANopen daisy chain RJ45 slot A Communication module CANopen SUB-D 9 slot A Communication module CANopen screw terminals slot A Digital and analog I/O extension module slot A/slot B Output relay extension module slot A/slot B Communication module Ethernet IP/Modbus TCP/MD-Link slot A

Complementary

Output voltage	\leq power supply voltage
Permissible temporary current boost	1.1 x I_n 60 s normal duty 1.5 x I_n 60 s heavy duty
Motor slip compensation	Automatic whatever the load Adjustable Can be suppressed Not available in permanent magnet motor law
Acceleration and deceleration ramps	Linear adjustable separately from 0.01...9999 s
Braking to standstill	By DC injection
Protection type	Safe torque off motor Motor phase break motor Safe torque off drive Overheating drive Short-circuit protection drive Motor phase break drive Overspeed drive Break on the control circuit drive Overvoltages on the DC bus drive Overload of output voltage drive Line supply overvoltage drive Line supply phase loss drive Line supply undervoltage drive Overcurrent between output phases and earth drive Thermal protection motor Thermal protection drive
Frequency resolution	Display unit Analog input
Electrical connection	Removable screw terminals 0.5...1.5 mm ² control M12 bar 3 3 x 185 mm ² line side maximum per phase normal duty M12 bar 4 3 x 120 mm ² line side maximum per phase normal duty M12 bar 3 3 x 185 mm ² motor maximum per phase normal duty M12 bar 4 3 x 120 mm ² motor maximum per phase normal duty M12 bar 3 3 x 185 mm ² line side maximum per phase heavy duty M12 bar 4 3 x 120 mm ² line side maximum per phase heavy duty M12 bar 3 3 x 185 mm ² motor maximum per phase heavy duty M12 bar 4 3 x 120 mm ² motor maximum per phase heavy duty M12 bar 3 3 x 150 mm ² line side minimum per phase normal duty M12 bar 4 3 x 95 mm ² line side minimum per phase normal duty M12 bar 2 3 x 185 mm ² motor minimum per phase normal duty M12 bar 3 3 x 120 mm ² motor minimum per phase normal duty M12 bar 2 3 x 185 mm ² line side minimum per phase heavy duty M12 bar 3 3 x 95 mm ² line side minimum per phase heavy duty M12 bar 2 3 x 185 mm ² motor minimum per phase heavy duty M12 bar 3 3 x 120 mm ² motor minimum per phase heavy duty

Type of connector	RJ45 Ethernet/Modbus TCP on the remote graphic terminal RJ45 Modbus serial on the remote graphic terminal
Physical interface	2-wire RS 485 Modbus serial
Transmission frame	RTU Modbus serial
Transmission rate	10/100 Mbit/s Ethernet IP/Modbus TCP 4.8, 9.6, 19.2, 38.4 kbit/s Modbus serial
Exchange mode	Half duplex, full duplex, autonegotiation Ethernet/Modbus TCP
Data format	8 bits, configurable odd, even or no parity Modbus serial
Type of polarization	No impedance Modbus serial
Number of addresses	1...247 Modbus serial
Method of access	Slave Modbus TCP
Supply	Internal supply for reference potentiometer (1 to 10 kOhm) 10.5 V DC +/- 5 % <= 10 mA overload and short-circuit protection External supply for digital inputs 24 V DC 19...30 V <= 1.25 mA overload and short-circuit protection Internal supply for digital inputs and STO 24 V DC 21...27 V <= 200 mA overload and short-circuit protection
Local signalling	3 LEDs local diagnostic 3 LEDs dual colour embedded communication status 4 LEDs dual colour communication module status 1 LED red presence of voltage
Width	600 mm
Height	2150 mm
Depth	605 mm
Product weight	400 kg
Analogue input number	3
Analogue input type	Software-configurable voltage AI1, AI2, AI3 0...10 V DC 30 kOhm 12 bits Software-configurable current AI1, AI2, AI3 0...20 mA/4...20 mA 250 Ohm 12 bits
Discrete input number	8
Discrete input type	Programmable DI1...DI6 24 V DC 3.5 kOhm Programmable as pulse input DI5, DI6 0...30 kHz 24 V DC Safe torque off STOA, STOB 24 V DC > 2.2 kOhm
Input compatibility	Level 1 PLC EN/IEC 61131-2 DI1...DI6 discrete input Level 1 PLC IEC 65A-68 DI5, DI6 discrete input Level 1 PLC EN/IEC 61131-2 STOA, STOB discrete input
Discrete input logic	Positive logic (source) DI1...DI6 < 5 V > 11 V Negative logic (sink) DI1...DI6 > 16 V < 10 V Positive logic (source) DI5, DI6 < 0.6 V > 2.5 V Positive logic (source) STOA, STOB < 5 V > 11 V
Analogue output number	2
Analogue output type	Software-configurable voltage AO1, AO2 0...10 V DC 470 Ohm 10 bits Software-configurable current AO1, AO2 0...20 mA 10 bits
Sampling duration	2 ms +/- 0.5 ms DI1...DI4 discrete input 5 ms +/- 1 ms DI5, DI6 discrete input 5 ms +/- 0.1 ms AI1, AI2, AI3 analog input 10 ms +/- 1 ms AO1 analog output
Accuracy	+/- 0.6 % AI1, AI2, AI3 for a temperature variation 60 °C analog input +/- 1 % AO1, AO2 for a temperature variation 60 °C analog output
Linearity error	+/- 0.15 % of maximum value analog input AI1, AI2, AI3 +/- 0.2 % analog output AO1, AO2
Relay output number	3
Relay output type	Configurable relay logic R1 fault relay NO/NC 100000 cycles Configurable relay logic R2 sequence relay NO 100000 cycles Configurable relay logic R3 sequence relay NO 100000 cycles
Refresh time	5 ms +/- 0.5 ms R1, R2, R3 relay output
Minimum switching current	5 mA 24 V DC R1, R2, R3 relay output
Maximum switching current	3 A 250 V AC resistive 1 R1, R2, R3 relay output 3 A 30 V DC resistive 1 R1, R2, R3 relay output 2 A 250 V AC inductive 0.4 7 ms R1, R2, R3 relay output 2 A 30 V DC inductive 0.4 7 ms R1, R2, R3 relay output
Isolation	Between power and control terminals
Specific application	Utility

IP degree of protection	IP21
Variable speed drive application selection	Building - HVAC compressor centrifugal Food and beverage processing other application Mining mineral and metal fan Mining mineral and metal pump Oil and gas fan Water and waste water other application Building - HVAC screw compressor Food and beverage processing pump Food and beverage processing fan Food and beverage processing atomization Oil and gas electro submersible pump (ESP) Oil and gas water injection pump Oil and gas jet fuel pump Oil and gas compressor for refinery Water and waste water centrifuge pump Water and waste water positive displacement pump Water and waste water electro submersible pump (ESP) Water and waste water screw pump Water and waste water lobe compressor Water and waste water screw compressor Water and waste water compressor centrifugal Water and waste water fan Water and waste water conveyer Water and waste water mixer
Motor power range AC-3	250...500 kW 380...440 V 3 phases
Motor starter type	Variable speed drive

Environment

Insulation resistance	> 1 mOhm 500 V DC for 1 minute to earth
Noise level	70 dB 86/188/EEC
Power dissipation in W	7810 W 2.5 kHz normal duty 5700 W 2.5 kHz heavy duty
Volume of cooling air	1300 m ³ /h
Operating position	Vertical +/- 10 degree
THDI	<= 48 % full load IEC 61000-3-12
Electromagnetic compatibility	Conducted radio-frequency immunity test level 3 IEC 61000-4-6 1.2/50 µs - 8/20 µs surge immunity test level 3 IEC 61000-4-5 Electrical fast transient/burst immunity test level 4 IEC 61000-4-4 Electrostatic discharge immunity test level 3 IEC 61000-4-2 Radiated radio-frequency electromagnetic field immunity test level 3 IEC 61000-4-3
Pollution degree	2 EN/IEC 61800-5-1
Vibration resistance	1.5 mm peak to peak 2...13 Hz IEC 60068-2-6 1 gn 13...200 Hz IEC 60068-2-6
Shock resistance	15 gn 11 ms IEC 60068-2-27
Relative humidity	5...95 % without condensation IEC 60068-2-3
Ambient air temp for op	-15...40 °C without derating 40...50 °C with derating factor
Ambient air temperature for storage	-40...70 °C
Operating altitude	1000...4800 m with current derating 1 % per 100 m <= 1000 m without derating
Environmental characteristic	Chemical pollution resistance class 3C3 EN/IEC 60721-3-3 Dust pollution resistance class 3S3 EN/IEC 60721-3-3
Standards	EN/IEC 61800-3 EN/IEC 61800-3 environment 2 category C3 UL 508C EN/IEC 61800-5-1 IEC 61000-3-12 IEC 60721-3 IEC 61508 IEC 13849-1
Product certifications	CSA TÜV REACH ATEX INERIS

Marking

CE

Offer Sustainability

Sustainable offer status

Green Premium product

RoHS (date code: YYWW)

Compliant - since 1516 - Schneider Electric declaration of conformity

[Schneider Electric declaration of conformity](#)

REACH

Reference not containing SVHC above the threshold

[Reference not containing SVHC above the threshold](#)

Product environmental profile

Available

[Product environmental](#)

Product end of life instructio

Available

[Product environmental](#)

Dimensions

Right and Front View

Clearances

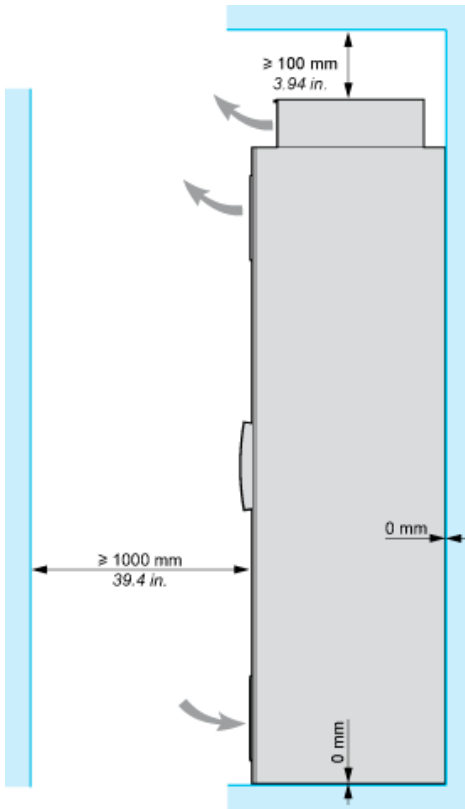

Floor Standing Drive Circuit Diagram

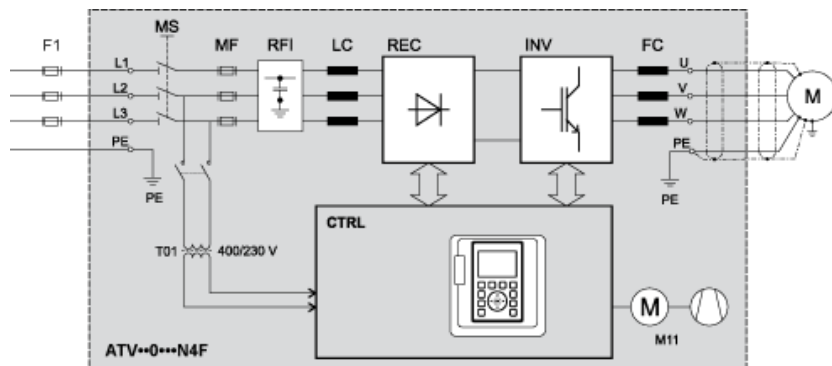

- F1 External pre-fuse or circuit breaker
- MS Built-in main switch (only available on IP54 drives)
- T01 Control transformer 400 / 230 V AC
- MF aR fuses
- RFI Built-in RFI filter
- LC Line reactor choke
- REC Rectifier module
- INV Inverter module
- FC dv/dt filter (from 355 kW the dv/dt filter choke 150 m is built-in as standard)
- CTRL Control panel
- M11 Fan in enclosure door

Control Block Wiring Diagram

- (1) Safe Torque Off
- (2) Analog Output
- (3) Digital Input
- (4) Reference potentiometer
- (5) Analog Input
- R1A, R1B Failure relay
- R2A, R2C Sequence relay
- R3A, R3C Sequence relay

Sensor Connection

It is possible to connect either 1 or 3 sensors on terminals AI2 or AI3.

Sink / Source Switch Configuration

The switch is used to adapt the operation of the logic inputs to the technology of the programmable controller outputs.

- Set the switch to Source (factory setting) if using PLC outputs with PNP transistors.
- Set the switch to Ext if using PLC outputs with NPN transistors.

Switch Set to SRC (Source) Position Using the Output Power Supply for the Digital Inputs

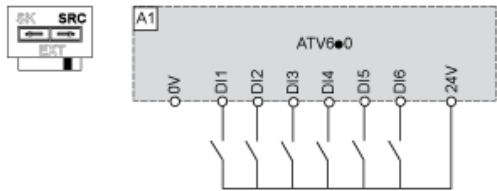

Switch Set to SRC (Source) Position and Use of an External Power Supply for the DIs

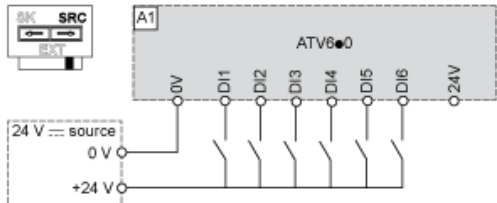

Switch Set to SK (Sink) Position Using the Output Power Supply for the Digital Inputs

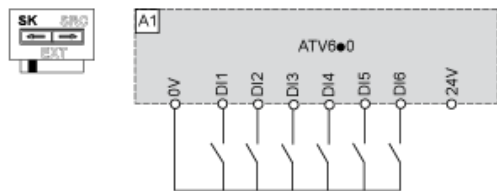

Switch Set to EXT Position Using an External Power Supply for the DIs

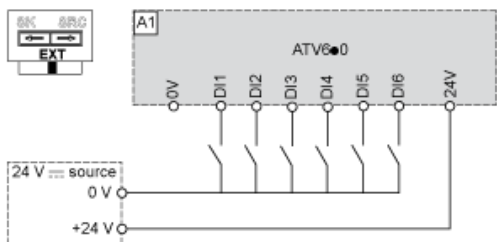

Derating Curves

Normal Duty

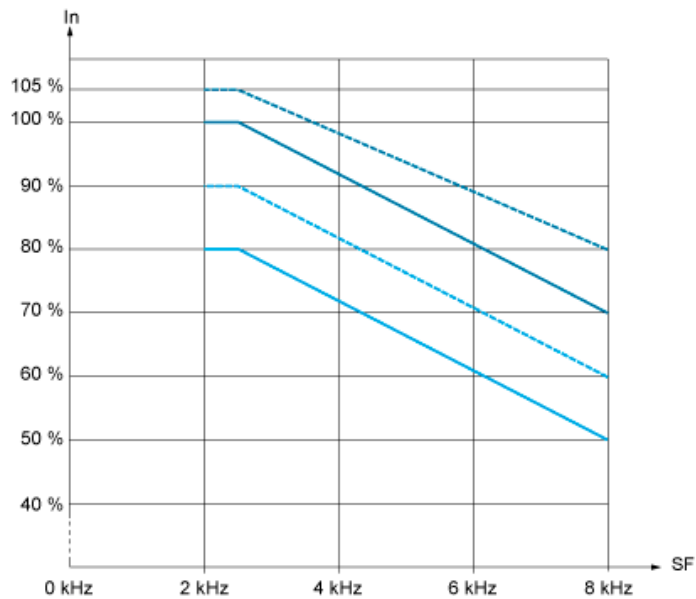

30 °C (86 °F)
40 °C (104 °F)
45 °C (122 °F)
50 °C (140 °F)

In : Nominal Drive Current
SF : Switching Frequency

Heavy Duty

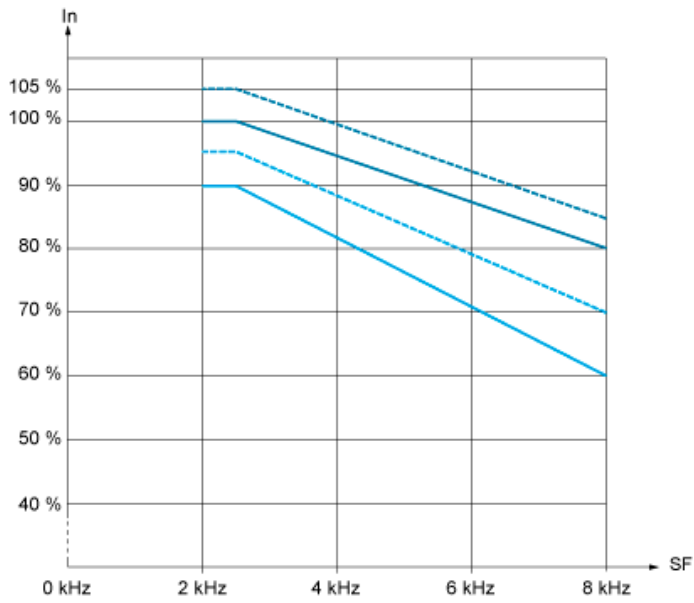

30 °C (86 °F)
40 °C (104 °F)
45 °C (122 °F)
50 °C (140 °F)

In : Nominal Drive Current
SF : Switching Frequency

Our Proposal: Circuit Breaker + Contactor + Drive for Motor Power 315 kW and 380 VAC

Motor power (kW)	Motor Starter	Information
315	 ATV630C31N4F	The base configuration is "ready to use" please contact an expert for further information.

Non contractual pictures.